

BSA Lead Screws

Easy running, precise and cost-effective positioning

Thomson BSA lead screws – easy running, precise and cost-effective positioning function, the optimum solution for your application.

The Thomson precision lead screws are an outstanding and economical solution to your linear motion requirements. Thomson has been active for more than 40 years developing and producing the highest quality lead screws in this industrial sector. Our precision rolling process guarantees precision positioning to 0.075 mm/300 mm, and our coating method using PTFE creates systems with a lower drag torque and a higher service life.

Thomson has a wide range of standard plastic nuts systems available, in the form of anti-backlash or standard Supernuts®. A composite material of acetal and PTFE is used in all these standard plastic nut systems, offering an outstanding lubricant capability with or without supplementary lubrication, at the same time achieving a low rate of wear. As a result of the introduction of our new, unique patented backlash-free method design, Thomson is able to offer systems with high axial stiffness, zero backlash and a very low drag torque, reducing the demands on the motor. This creates more cost-effective products with a higher performance and longer service life. The two designs automatically adapt to the wear conditions, so that zero backlash is guaranteed for the life of the nut.

Thomson also offers a design service for your application requirements. This means that lead screws can be manufactured to meet your specifications. Get in touch with Thomson today and discuss your application with our experienced product specialists.

Product Considerations

Reducing backlash is of decisive importance in ensuring precise positioning. Several types of preload variants, which all use a resilient preload are available on the market. As these mechanisms are only limited in their stiffness, a high preload is necessary to retain the position. This leads to a high drag torque, shorter service life and reduced performance. The costs for the system increase and a larger motor is required.

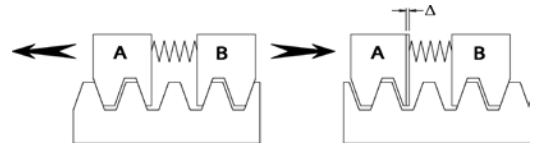

The solution – THOMSON

With the introduction of the patented XC series of nuts with **ActiveCAM**, optimum axial stiffness with minimum drag torque at the same time is achieved. The use of an extremely stiff stainless steel sleeve for the preload leads to an incomparable axial stiffness. The axial backlash is rectified without high preloading and so the lowest possible drag torque is achieved.

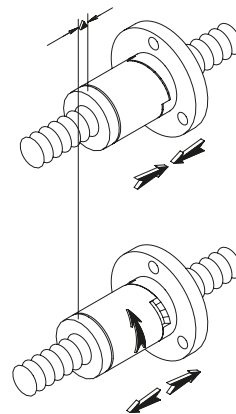

Readjusting the preloading following wear

The wear occurring over time is automatically compensated for by the unique **ActiveCAM** mechanism, without sacrificing stiffness and positioning accuracy, or influencing the drag torque. US Patent #5839321 and one or more foreign equivalents.

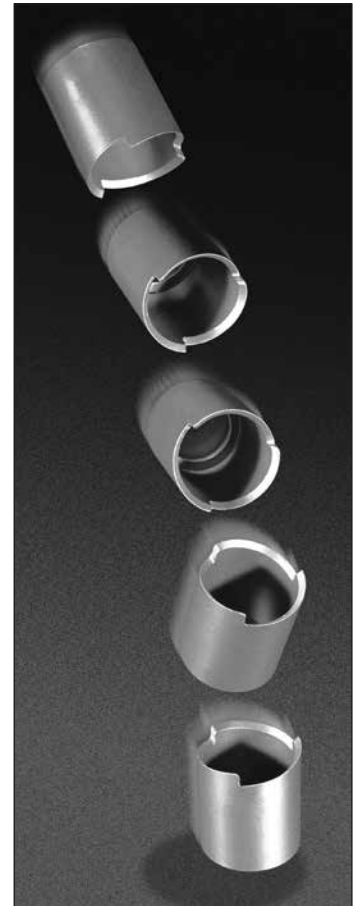

Glide Screw Overview

What is a Glide Screw™? Part linear bearing, part lead screw; a combination of two favorites to create something better than both. The patent-pending Glide Screw™ brings high performance, fast installation and less complexity in a small package. The Glide Screw™ combines the features of a linear bearing and a lead screw in one smooth operating package. Inch and metric sizes are standard. Custom sizes are also available quickly and to your specification.

Standard Sizes and Configurations Stocked for Immediate Availability!

- Metric Series includes 4, 6 and 10 mm nominal diameters
- Inch Series includes 3/16", 1/4" and 3/8" nominal diameters
- Flanged and cylindrical nut bodies standard

Optional Configurations for Harsh Environments Available

- High temperature resistant – inside ovens or autoclaves (up to 175 °C)
- Clean room – in robot vacuum chambers, laboratories or medical equipment (ISO 6)
- Food grade – in packaging and food processing equipment

Custom Nut Configurations, Screw Diameters and Thread Leads Available

- Don't see your perfect configuration – call us, we make custom sizes!

Easy to Install and Maintenance Free!

- All that is required is a Glide Screw™ and an anti-rotation feature
- No need for reference surfaces or the pain of "floating" your system into alignment
- Plug and play! Install it and forget it!
- Integrated Thomson's patented Lube for Life technology
- Bearing grade plastic and stainless steel construction standard

Reduced Footprint

- Integrated lead screw / linear bearing
- Side load / moment load capable

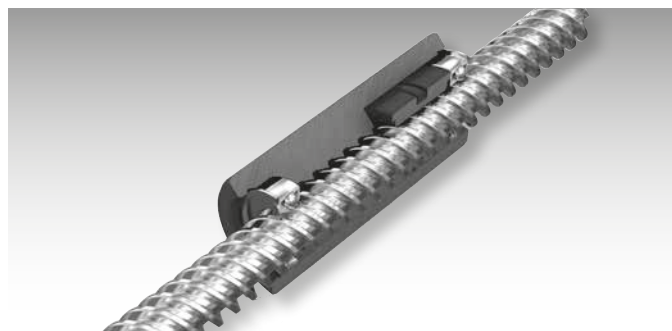

Improved Equipment Uptime

- Screw and linear bearing are already aligned
- Component alignment is not critical – smooth and quiet motion
- Integrated lubrication block – Thomson Lube for Life standard

Lower Cost of Ownership

- Less complexity – faster installation
- Less components – simpler bill of material
- Maintenance free! No lubrication required

For more information about Thomson Glide Screws, visit www.thomsonlinear.com/glidescrew or contact your local Thomson Field Sales Engineer.

NEW Thomson Motorised Lead Screws

New Motorised Lead Screws from Thomson combine a hybrid stepper motor and a precision lead screw together in one compact envelope. Patent-pending Taper-Lock technology allows quick decoupling and secure, properly aligned connections. This combination offers several advantages over a traditional solution and make the end product smaller, stronger, quieter and more efficient.

Increased Torque Density

- Increased load capacity by up to 30 % while maintaining the same motor footprint

Improved Efficiency

- Reduced power consumption, improved operating battery life, and decreased motor footprint for an increase in system load performance or reduction in power consumption - all while having a lower cost of ownership.

The Taper Lock Advantage

- Quick decoupling of the lead screw from the stepper motor due to new patent pending Taper Lock design for a secure, robust, and properly aligned connection.

Reduced Noise

- Optimised motor configuration and windings to limit motor harmonics and reduce motor noise at application operating points.

COMING SOON!



E-mail Thomson at sales.europe@thomsonlinear.com to receive information on the new Thomson Motorised Lead Screw when it becomes available for sale.

Quality lead screws

- ActiveCAM technology
- High-quality plastic nuts
- High precision

Fields of application for lead screws

Engraving machines

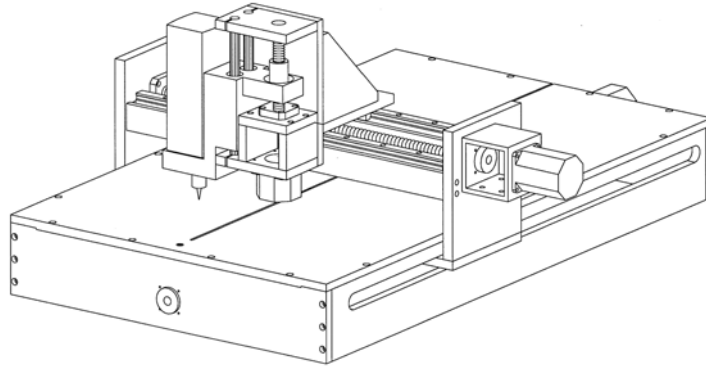

Medical equipment

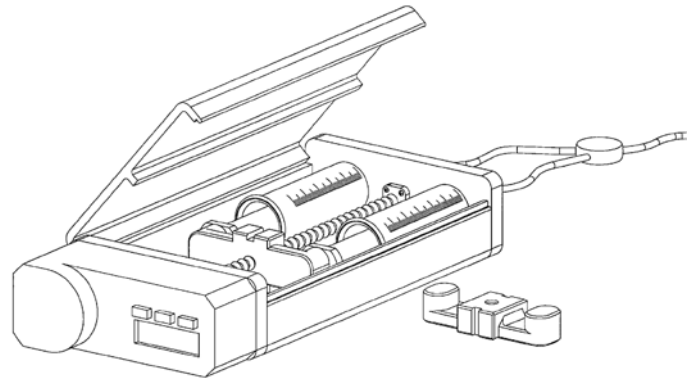

Semiconductor production

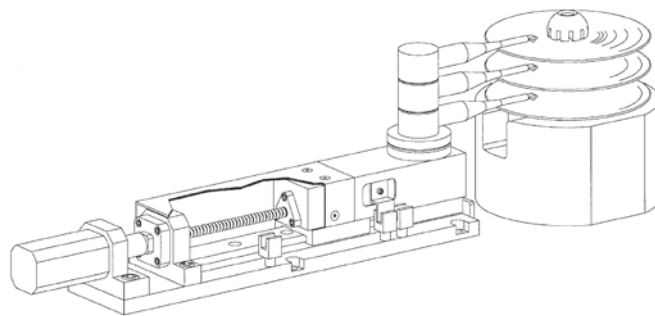

Laboratory equipment

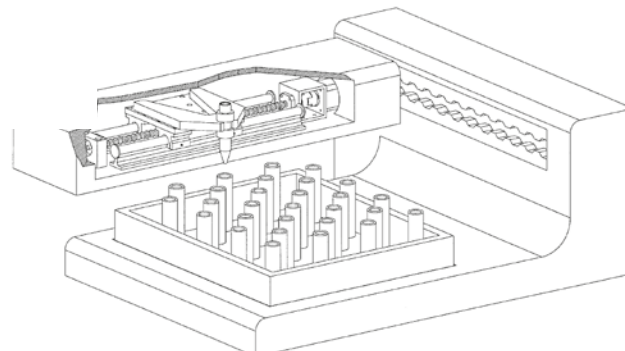

Precision lead screws and Supernuts®

Features/benefits

Low costs

Considerable savings over ball screws.

Variety

Huge selection of leads and diameters.

Lubrication

Internally lubricated plastic nuts may be used without supplementary lubrication. We nevertheless recommend the use of TriGEL grease or a dry lubricant to extend the service life. See page 13.

Vibration and noise generation

No vibration from ball recirculation and frequently less audible noise generation by comparison with recirculating ball screws.

Aspects of the design

Load

Supernuts are a cost-effective solution for medium to light loading. In vertical applications, the Anti-Backlash Supernuts should be mounted with the thread/flange on the underside.

Unilateral load

Unilateral loads that may exert a torque on the nut will lead to premature failure.

Critical speed

See critical speed graph on page 6.

Buckling load

See buckling load graph on page 7.

Self-locking

Lead screws can be self-locking at small leads. For the best possible operating conditions, the shaft pitch should always be greater than 1/3 of the nominal diameter.

Customized solution

Ability to adapt the components to your application.

Corrosion resistant*

Stainless steel shafts, Acetal nuts.

Environment

Less susceptible to contamination by particles than recirculating ball screws.

Low weight

There is less mass to move.

Temperature

The heat generated by the environment and friction is the principal cause for premature failure of the plastic nuts. Note the limit values for temperature listed below and discuss your application with regard to continuous operation, high loading and high-speed applications with our product specialists. Thomson recommends bronze nuts for very high temperature environments. We will also be pleased to advise you on the selection of a high temperature plastic for a custom application.

Efficiency

The following is true except for very large leads: the greater the lead, the better the efficiency. Even though acetal in combination with PTFE has excellent lubricating properties, recirculating ball screws have significantly greater efficiency than lead screws. See page 12 for the actual efficiency.

Length limit values

Shaft diameter	maximum length
10 mm	1200 mm
12–16 mm	1800 mm
>16 mm	3600 mm

Pitch precision

Standard quality (SRA)	250 µm/300 mm
Precision quality (SPR)	75 µm/300 mm

Mounting		Shafts	Nuts**			
Maximum temperature	Coefficient of friction	Material	Material	Tensile strength	Water absorption (24 hour %)	Coefficient of thermal expansion
82 °C	0.08 - 0.14	Stainless steel*	Acetal with PTFE	55 N/mm ²	0.15	9.7 x 10 ⁻⁶ 1/°C

* 1.4301 (AISI 304) and 1.4305 (AISI 303)

** Other materials available on a custom basis.

Useful formulas for lead screws

TORQUE, ROTARY LINEAR

Drive on the shaft to move the nut, or drive on the nut to move the shaft.

$$\text{Torque} = \frac{\text{load (N)} \times \text{lead (mm)}}{2\pi \times \text{efficiency}} \quad (\text{Nmm})$$

EFFICIENCY

$$\% \text{ efficiency} = \frac{\tan(\text{pitch angle})}{\tan(\text{pitch angle} + \text{"arctan"} f)} \times 100$$

f = coefficient of friction

TORQUE, LINEAR ROTARY

Load on the nut to rotate the shaft.

$$\text{Torque} = \frac{\text{load} \times \text{lead} \times \text{efficiency}}{2\pi}$$

As a rule, the following is true: Systems with an efficiency of 50 % and greater are not self-locking. For efficiency see page 12. The efficiencies listed in the catalog are calculated for a coefficient of friction of 0.1.

Graph of critical rotational speed limit values

Every lead screw has a rotational speed limit. This is the point at which the rotational speed sets up heavy vibration. This critical point changed depending on the end bearing supports used and the bearing combination.

To use this chart, you must determine the speed of rotation required and the maximum length between the bearing supports. Then select one of the four bearing combinations shown below. The critical speed limit can be found by locating the point at which the speed of rotation (horizontal lines) intersects with the unsupported shaft length (vertical lines) as modified by the bearing combination listed below. It is recommended that the lead screws be operated at no more than 80% of the critical speed limit value.

Warning: The graphs for the shaft diameters illustrated are based on the smallest minor diameter of a standard shaft within the nominal size range and are cut off at the maximum speed of rotation for the nut. This value for the rotational speed **MAY NOT BE EXCEEDED**, whatever the shaft length.

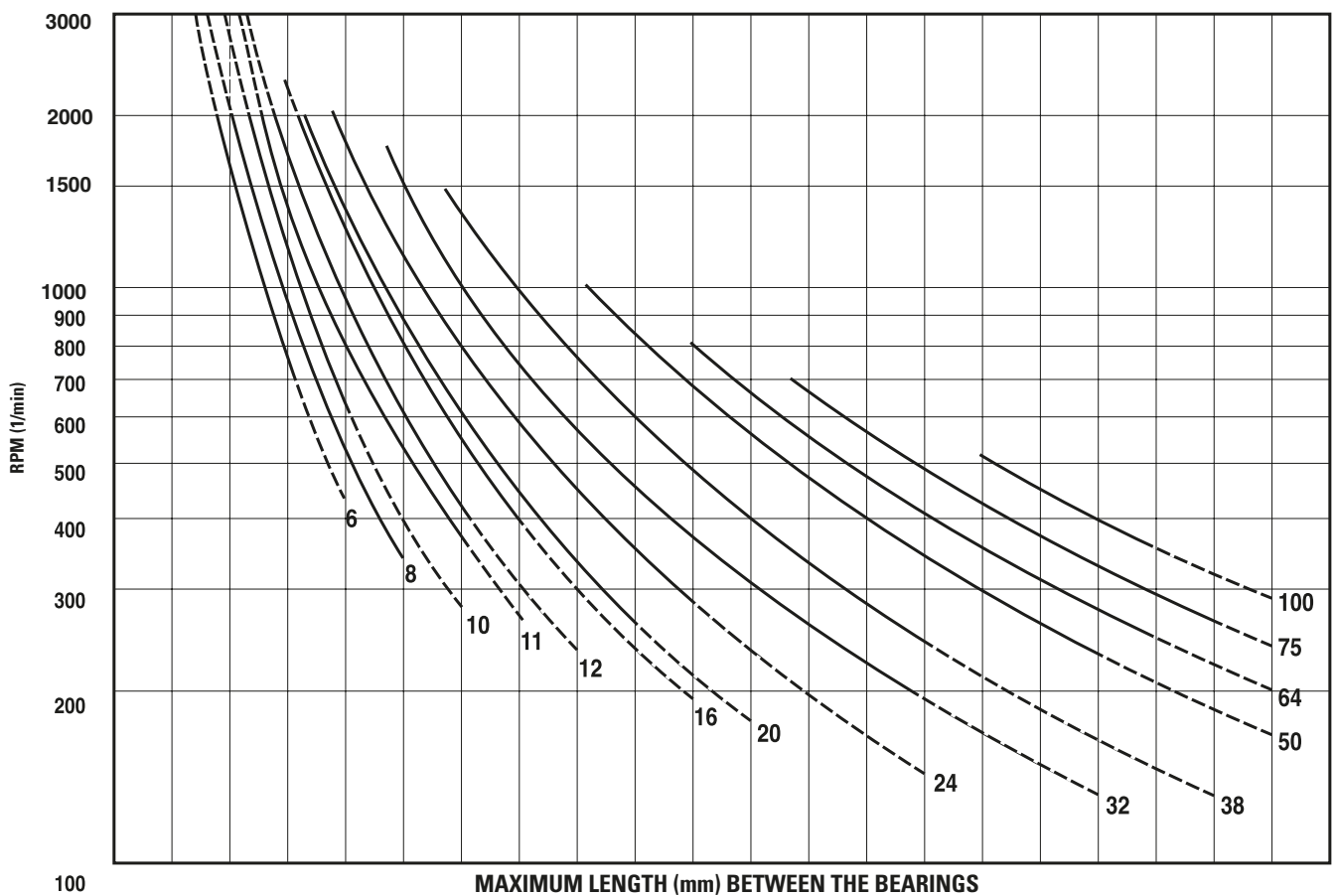

Bearing scenario 1	150	300	460	610	760	910	1070	1220	1370	1520	1680	1830	1980	2130	2290	2440	2590	2740	3050	3200
Bearing scenario 2	250	510	760	1020	1270	1520	1780	2030	2290	2540	2790	3050	3300	3560	3810	4060	4320	4570	4830	5080
Bearing scenario 3	300	610	910	1220	1550	1850	2160	2460	2770	3070	3380	3910	4010	4320	4620	4930	5230	5540	5840	6150
Bearing scenario 4	380	760	1140	1520	1910	2290	2670	3020	3400	3780	4170	4550	4930	5310	5690	6070	6450	6830	7210	7570

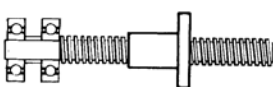

Bearing scenario 1

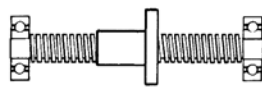

Bearing scenario 2

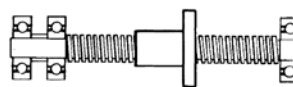

Bearing scenario 3

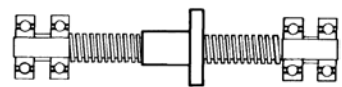

Bearing scenario 4

Graph of critical buckling force

This graph is used to determine the maximum compression loading on the shafts. Normally, shafts operated under tensile stress are capable of withstanding a loading up to the design load capacity of the nut. The bearing combinations influence the load capacity of the shaft. The four standard variants are listed below with the corresponding bearing scenarios. To determine the safe minimum diameter of the shaft, you must determine the point at which the graphs for the compressive load (horizontal) and the shaft length (vertical) intersect. Consult the manufacturer if the loading values lie in the area of the dotted lines.

Warning: The load capacity of the nuts MAY NOT BE EXCEEDED. The curves for the shaft diameter are based on the smallest minor diameter of a standard shaft within the nominal size range.

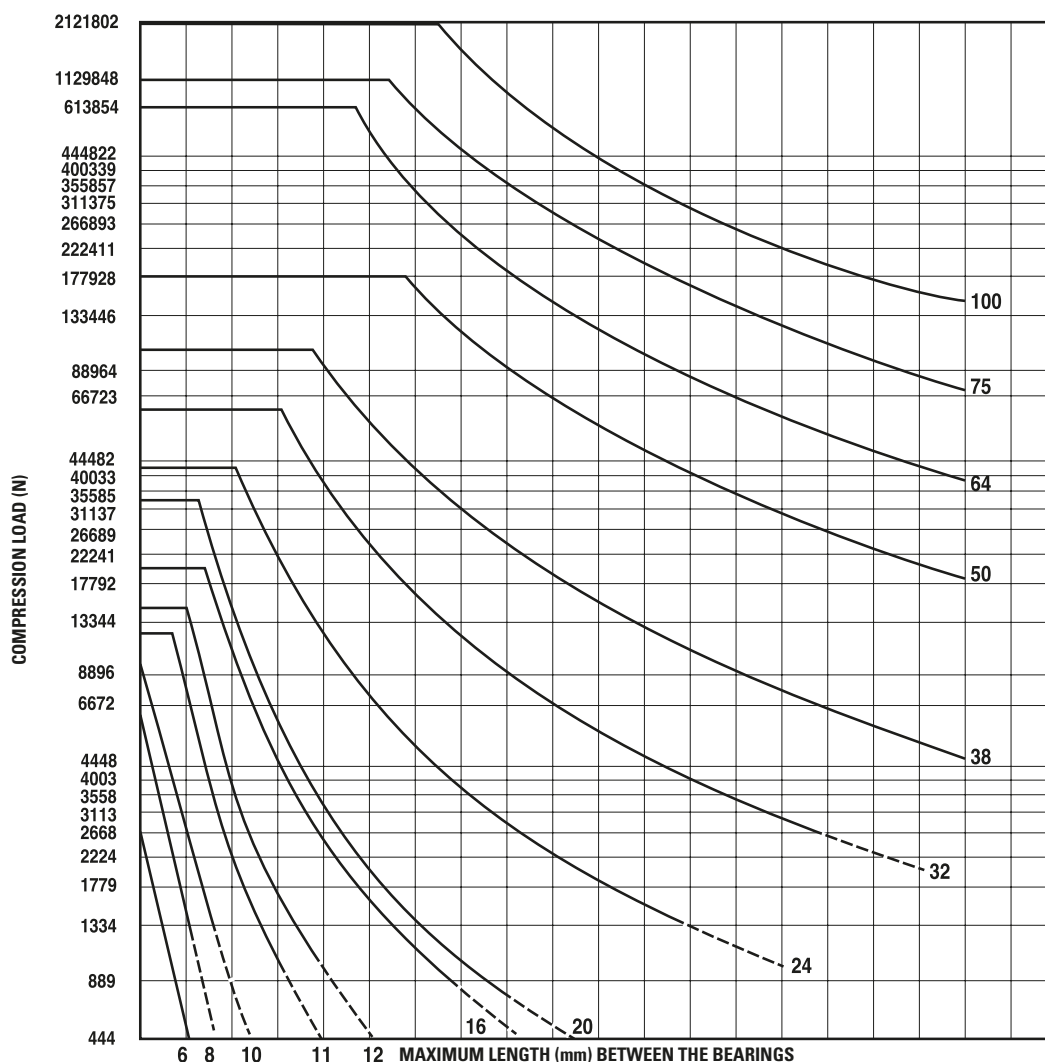

Bearing scenario 1	130	250	380	510	640	760	890	1020	1140	1270	1400	1520	1650	1780	1910	2030	2160	2290	2410
Bearing scenario 2	250	510	760	1020	1270	1520	1780	2030	2290	2540	2790	3050	3300	3560	3810	4060	4320	4570	4830
Bearing scenario 3	360	710	1070	1450	1800	2160	2510	2870	3230	3580	3960	4320	4670	5030	5380	5740	6100	6480	6860
Bearing scenario 4	510	1020	1520	2030	2540	3050	3560	4060	4570	5080	5590	6100	6600	7110	7620	8130	8640	9140	9650

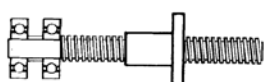

Bearing scenario 1

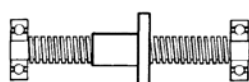

Bearing scenario 2

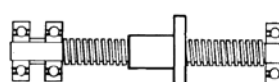

Bearing scenario 3

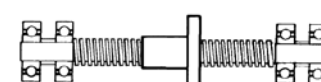

Bearing scenario 4

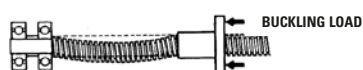

Compression load (buckling load)



Tensile load

Lead screw product features

Series	Thomson precision lead screw
Lead precision	Standard - 250 µm/300 mm Precision - 75 µm/300 mm
Diameter	4 to 24 mm
Lead	1 to 50 mm
Backlash	0.02 to 0.25 mm (standard nut) backlash-free version available
Dynamic load	up to 1550 N
Maximum static load	up to 6675 N

Lead screw product availability

Metric

Diameter (mm)	Lead (mm)																
	1	2	3	4	5	6	8	10	12	15	16	18	20	25	35	45	50
4	●			●			●										
6	●					●			●			●					
10		● ○	●	●	●	●		●	●				●				
12			●	●	●	●		●		●				●		●	
16				● ○	●		●				●			●	●		
20				● ○			●		●		●		●			●	●
24					● ○												

● = size with right hand thread in stock ○ = size with left hand thread in stock

Inch

Diameter (inches)	Lead (inches)																		
	0.031	0.050	0.063	0.083	0.100	0.125	0.167	0.200	0.250	0.300	0.375	0.400	0.500	0.750	0.800	1.000	1.200	1.500	2.000
3/16		●			●	●		●			●	●	●						
1/4	●	●	●			●		●	●				●	●					
5/16				●			●		●				●			●			
3/8		●	●	●	●	●	●	●	●	●	●		●	●		●	●		
7/16						●			●				●						
1/2			●		●			●	●				●		●	●		●	
5/8					●	●		●	●				●						
3/4					●	●	●	●					●			●		●	●
1					●	●		●	●				●			●			

Note: Miniature sizes are also available. Customized diameters and leads on request.

Ordering information

Thomson designs the lead screws for optimum performance. To ensure correct operation, it is recommended that our nuts and shafts are used only with the appropriate Thomson products, as manufactured by Thomson. This is of particular importance in the case of our own thread dimensions. Select a shaft size complying with DIN from page 12 if interchangeability is a requirements criterion.

The use of a lubricant is recommended for the operation of a lead screw with a plastic nut. This increases the service life of the unit and the permissible operating load.

Note: The load indications in the catalog are based on the use of a lubricant.

See pages 13 and 14 for lubrication options.

Nut part number
(see pages 10 and 11)

<p>Prefix for nut style number (letters only - 2 - 4 characters)</p>				<p>Shaft size from table on page 12. (No statement of precision prefix)</p>

Example

X	C	B	10x2M
---	---	---	-------

Note: Make sure the nut you selected is offered for use with the shaft diameter selected. See "Shaft series" on pages 10 and 11 to verify.

Shaft part numbers (see page 12)

				-
<p>Precision prefix (3 letters for precision or standard accuracy)</p>			<p>Shaft size (indication of diameter and lead)</p>	<p>Shaft length (please state units - preferably mm)</p>

Example

S	P	T	10x2M	150 mm
---	---	---	-------	--------

The shaft and nut are designed to work together properly where these two components have the same suffix for the shaft size (see examples listed above).



XC series – The leading performer

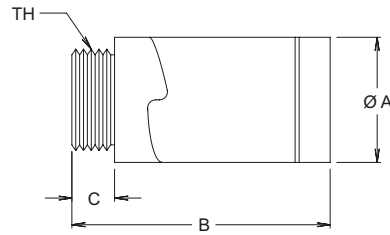

Threaded nut style

Model no.	Shaft diameter (mm)	May also be used with inch thread	Dimensions				Permissible dynamic load (N)	Drag torque	
			A (mm)	B (mm) max	C (mm)	TH (mm)		min. (Nmm)	max. (Nmm)
XCB3700	10	5/16, 3/8	20.8	47.6	6.4	M16 x 1.5	100	7	21
XCB5000	12	7/16, 1/2	28.4	57.2	9.5	M25 x 1.5	550	7	21
XCB6200	16	5/8	35.6	66.0	12.7	M30 x 1.5	775	14	42
XCB7500	20	3/4	41.4	73.7	12.7	M35 x 1.5	1100	21	71
XCB10000	24	1	47.8	76.2	15.2	M40 x 1.5	1550	35	71

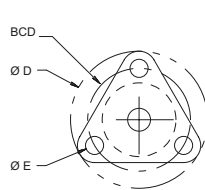

XCMF1800, XCF3700

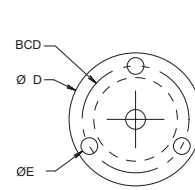
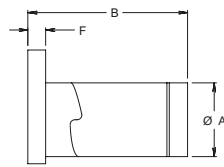

XCF5000, XCF6200

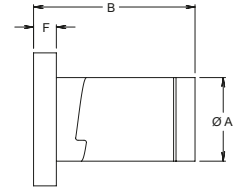

Flanged nut style

Model no.	Shaft diameter (mm)	May also be used with inch thread	Dimensions						Permissible dynamic load (N)	Drag torque	
			A (mm)	B (mm) max	D (mm)	E (mm)	F (mm)	BCD (mm)		min. (Nmm)	max. (Nmm)
XCMF1800	6	3/16, 1/4	12.7	22.9	25.4	3.6	4.6	19.1	22	0	7
XCF3700	10	5/16, 3/8	20.8	47.6	38.1	5.1	5.1	28.6	100	7	21
XCF5000	12	7/16, 1/2	28.4	57.2	44.5	5.6	7.6	35.5	550	7	21
XCF6200	16	5/8	35.6	66.0	54.1	5.6	12.7	42.9	775	14	42

AFT3700 - The OEM solution

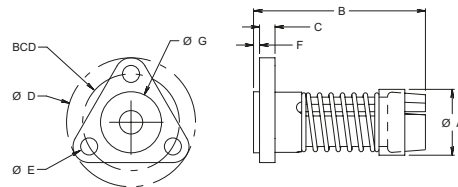

Flanged nut style

Model no.	Shaft diameter (mm)	May also be used with inch thread	Dimensions							Permissible dynamic load (N)	Drag torque		
			A (mm)	B (mm)	C (mm)	D (mm)	E (mm)	F (mm)	G (mm)		BCD (mm)	min. (Nmm)	max. (Nmm)
AFT3700	10	3/8, 7/16	19.6	50.8	5.1	38.1	5.1	1.5	18.0	28.6	45	14	35

See page 9 for notes on ordering

SB series – Compact screw nuts

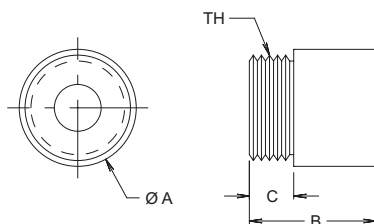

Threaded nut style

Model no.	Shaft diameter (mm)	May also be used with inch thread	Dimensions				Permissible dynamic load (N)	Maximum static load (N)	Drag torque
			A (mm)	B (mm)	C (mm)	TH (mm)			
SB3700	10	5/16, 3/8	19.1	19.1	6.4	M16 x 1.5	310	1550	No preloading
SB5000	12, 16	7/16, 1/2	25.4	25.4	9.5	M22 x 1.5	445	2225	
SB1000	20, 24	3/4, 1	38.1	38.1	12.7	M35 x 1.5	1335	6675	

MTS and RSF series - Simple to fit flanged nut

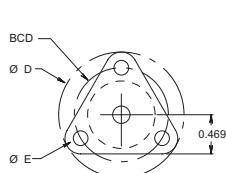

RSF1800, MTS3700

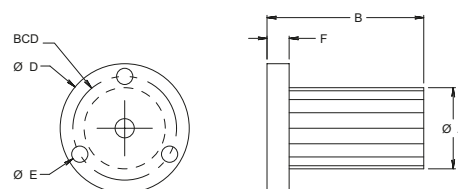

MTS5000, MTS6200, MTS7500

Flanged nut style

Model no.	Shaft diameter (mm)	May also be used with inch thread	Dimensions						Permissible dynamic load (N)	Drag torque
			A (mm)	B (mm)	D (mm)	E (mm)	F (mm)	BCD (mm)		
RSF1800	4	3/16	8.0	9.5	19.1	3.2	3.2	12.7	45	No preloading
MTS2500	6	1/4	12.7	19.1	25.4	3.6	3.8	19.1	110	
MTS3700	10	3/8, 7/16	18.0	38.1	38.1	5.1	5.1	28.6	325	
MTS5000	12	1/2	19.1	38.1	38.1	5.1	6.4	28.6	550	
MTS6200	16	5/8	22.4	41.4	38.1	5.1	7.6	30.2	775	
MTS7500	20	3/4	28.6	44.5	50.8	5.1	7.6	36.5	1200	

See page 9 for notes on ordering

Note: The permissible loading describes the maximum operating load with lubrication at room temperature, 50 % duty time and 500 rpm. Increasing the speed of rotation will lead to a reduction in the maximum operating load. At 1000 rpm, the operating load is approximately 50 % of the permissible load.

Metric stainless steel precision trapezoidal thread lead screw shafts

Rolled precision trapezoidal thread lead screws have a polished finish and thus offer optimum efficiency and low wear. All shafts are made from stainless steel to ensure resistance to corrosion and a smooth finish. SPT and SRT shafts comply with the requirements of DIN 103, while SPR and SRA shafts have improved thread forms for high performance.

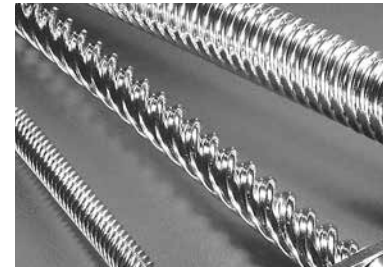

Shaft diameter (mm)	Lead (mm)	Part number			Minor diameter (mm)	Efficiency with coefficient of friction of 0.1 (%)
		Prefix for precision accuracy	Prefix for standard accuracy	Size		
4	1	SPR	SRA	4 x 1M	2.7	48
	4	SPR	SRA	4-4 x 1M	2.7	76
	8	-	SRA	8-4 x 1M	2.7	82
6	1	SPR	SRA	6 x 1M	4.6	37
	6	SPR	SRA	4-6 x 1.5M	4.5	69
	12	-	SRA	8-6 x 1.5M	4.5	81
	18	-	SRA	9-6 x 2M	4.5	82
10	2*	SPT	SRT	10 x 2M	7.4	42
	3 [^]	SPT	SRT	10 x 3M	6.4	53
	4	SPT	SRT	2-10 x 2M	7.4	59
	5	SPR	SRA	2-10 x 2.5M	7.1	64
	6	SPR	SRA	4-10 x 1.5M	8.2	66
	10	SPR	SRA	5-10 x 2M	7.5	76
	20	-	SRA	6-10 x 3.3M	8.4	81
12	3*	SPT	SRT	12 x 3M	8.0	48
	4	SPR	SRA	2-12 x 2M	9.2	54
	5 [^]	SPT	SRT	2-12 x 2.5M	8.9	59
	6	SPR	SRA	3-12 x 2M	9.1	63
	10 [^]	SPT	SRT	4-12 x 2.5M	8.9	73
	15	SPR	SRA	6-12 x 2.5M	8.7	78
	25	-	SRA	10-12 x 2.5M	9.2	82
	45	-	SRA	15-12 x 3M	9.6	81
16	4*	SPT	SRT	16 x 4M	11.3	48
	5	SPR	SRA	2-16 x 2.5M	12.2	52
	8	SPR	SRA	4-16 x 2M	13.0	63
	16	SPR	SRA	7-16 x 2.3M	12.6	75
	25	-	SRA	5-16 x 5M	11.5	80
	35	-	SRA	7-16 x 5M	12.2	82
20	4*	SPT	SRT	20 x 4M	15.3	42
	8	SPR	SRA	2-20 x 4M	14.8	59
	12	SPR	SRA	3-20 x 4M	15.0	67
	16	SPR	SRA	4-20 x 4M	15.0	72
	20	-	SRA	5-20 x 4M	15.0	76
	45	-	SRA	9-20 x 5M	15.8	82
	50	-	SRA	10-20 x 5M	16.5	82
24	5*	SPT	SRT	24 x 5M	18.5	42

*complies with the requirements specified in DIN 103 Parts 1 and 2. Tolerance class 7e.

[^]*complies with the requirements specified in DIN 103 Part 1, not defined in Parts 2 and 3.

See page 5 for maximum available shaft lengths

See page 9 for notes on ordering

Lubrication



Overview

We offer a complete range of lubricants including our greases for clean room and vacuum uses. The TriGel product range has been especially developed to provide a lubrication solution for a wide range of applications in linear motion systems. Select the lubricant suited to your requirements.

This will ensure that you get the best performance from your Thomson products.

Lubrication selection table for trapezoidal thread lead screws

Thomson	TriGel-300S	TriGel-450R	TriGel-600SM	TriGel-1200SC	TriGel-1800RC
Application	Lead screws, Supernuts, plastic nuts	Ball screw linear bearings	Bronze nuts	Lead screws, plastic nuts clean room, high vacuum	Ball screw linear bearings, bronze nuts, clean room, vacuum
Maximum temperature	200 °C (392 °F)	125 °C (257 °F)	125 °C (257 °F)	250 °C (482 °F)	125 °C (257 °F)
Loaded material	plastic on plastic or metal	Metal on metal	Metal on metal bronze on steel	plastic or metal, combination	Metal on metal
Mechanical load	slight	medium	medium to heavy	slight to medium	medium
Very low torque change in relation to the temperature	yes	—	—	yes	—
Very low starting torque	yes	yes	—	yes	yes
Compatibility with reactive chemicals	not recommended without OEM testing	not recommended without OEM testing	not recommended without OEM testing	possible	not recommended without OEM testing
Compatibility with plastics and elastomers	can lead to swelling of the silicon rubber seal	can lead to swelling of the EPDM seal	can lead to swelling of the EPDM seal	possible	can lead to swelling of the EPDM seal
Clean room use	not recommended	not recommended	not recommended	possible	possible
Use in high vacuum	not recommended	not recommended	not recommended	possible	possible
Vapor pressure (25 °C)	changes with volume	changes with volume	changes with volume	1 x 10 ⁻⁶ Pa	0.5 x 10 ⁻⁶ Pa
Packaging 10 cc syringe 0.45 kg tube	TriGel-300S TriGel-300S-1	7832867/ TriGel-450R 7832868/ TriGel-450R-1	0.1 kg tube/ TriGel-600SM	TriGel-1200SC n.a.	7832869/ TriGel-1800RC

* Maximum temperature for continuous exposure. Higher temperatures may be permissible but should be validated in the actual end use by the OEM.
Low temperature limits are -15°C or lower. Further information may be obtained from Thomson.

PTFE dry lubricant

Developed for trapezoidal lead screw applications with plastic on metal



A PTFE coating comprises a dry coating, forming a lubricating and barrier layer between the metal substrate and the polymer nut or ball nut. This means that the application of an additional lubricant that must be renewed is unnecessary in many cases.

The coating is very well suited to our XC (SuperNut) series, comprising plastic nuts and stainless steel lead screws. Service intervals for lubrication are no longer necessary, and the coating does not attract particles of dirt as a lubricant does. Although lower coefficients of friction are possible with a lubricant than with a dry lubricant, lubrication must be maintained to avoid a drop in performance. Coating with PTFE is an attractive and cleaner* alternative to greases and oils.

Typical features

Type:	Connection with solid lubricant
Aim:	Increased lubrication, reduced friction/wear
Appearance:	Black coating
Thickness:	Approximately 13 – 25 µm
Active lubricant:	Polytetrafluorethylene
Coefficient of friction:	0.06 to 0.12
Operating temperature range for the coating:	-250 °C to 290 °C
Acid resistance:	Outstanding
Resistance to alkali:	Very good
Resistance to solvents:	Outstanding

*Some particles are generated by the wear between the nut and the shaft. Over time, the shaft can show signs of a polished finish. This is not necessarily an indication of a malfunction.

Inquiry form

Contact address

Company:

Address:

Contact: Contact:

Phone: Phone:

Fax: Fax:

e-mail: e-mail:

Recirculating ball screw parameters

Diameter: mm Lead: mm Thread direction: Clockwise Counter-clockwise

Precision: /300 mm Nut design: Backlash-free: Preloaded: Backlash:

Stroke length: mm Track length: mm Total length: mm

Application:

Environment:

Lubrication: Oil Grease

Quantity: Annual requirement: Quantity: Delivery lot:

Mounting the ball screw

Motion system element: Shaft Nut Mounting position: Horizontal Vertical Diagonal

Maximum speed: Rpm Maximum load: kN

Bearing scenario:

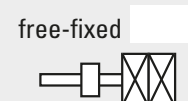
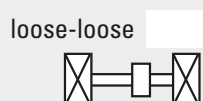
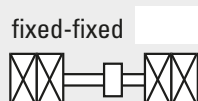

Load/service life specifications

Usage:			Load (N)	Speed (m/s)	Time period (s)
Required service life:	<input type="text"/> x10 ⁶ rev.	F ₁	<input type="text"/>	<input type="text"/>	<input type="text"/>
Required service life:	<input type="text"/> hrs	F ₂	<input type="text"/>	<input type="text"/>	<input type="text"/>
Minimum dynamic load:	<input type="text"/> kN	F ₃	<input type="text"/>	<input type="text"/>	<input type="text"/>

Module construction options

- Shafts, cut to length, with ready-mounted nuts
- Shafts, cut to length, with separately supplied nuts
- Shafts, annealed ends, with ready-mounted nuts
- Shafts, annealed ends, with separately supplied nuts
- Shafts, fully machined, with ready-mounted nuts
- Shafts, fully machined, with ready-mounted nuts and bearing units

EUROPE

United Kingdom

Thomson
Phone: +44 (0) 1271 334 500
Fax: +44 (0) 1271 334 501
E-mail: sales.europe@thomsonlinear.com

USA, CANADA and MEXICO

Thomson
203A West Rock Road
Radford, VA 24141, USA
Phone: 1-540-633-3549
Fax: 1-540-633-0294
E-mail: thomson@thomsonlinear.com
Literature: literature.thomsonlinear.com

SOUTH AMERICA

Thomson
Sao Paulo, SP Brazil
Phone: +55 11 3879-6600
Fax: +55 11 3879 6656
E-mail: sales.brazil@thomsonlinear.com

ASIA

Asia Pacific

Thomson
750, Oasis, Chai Chee Road,
#03-20, Technopark @ Chai Chee,
Singapore 469000
E-mail: sales.apac@thomsonlinear.com

China

Thomson
Rm 2205, Scitech Tower
22 Jianguomen Wai Street
Beijing 100004
Phone: +86 400 6661 802
Fax: +86 10 6515 0263
E-mail: sales.china@thomsonlinear.com

India

Thomson
1001, Sigma Building
Hiranandani Business Park
Powai, Mumbai – 400076
Phone: +91 22 422 70 300
Fax: +91 22 422 70 338
E-mail: sales.india@thomsonlinear.com

Japan

Thomson
Minami-Kaneden 2-12-23, Suita
Osaka 564-0044 Japan
Phone: +81-6-6386-8001
Fax: +81-6-6386-5022
E-mail: csinfo_dicgj@danaher.co.jp

Korea

Thomson
F12 Ilsong Bldg, 157-37
Samsung-dong, Kangnam-gu,
Seoul, Korea (135-090)
Phone: +82 2 6917 5049
Fax: +82 2 6917 5007
E-mail: sales.korea@thomsonlinear.com

www.thomsonlinear.com

BSA_Lead_Screws_BRUK-0013-01A | 20141013 SK
Specifications are subject to change without notice. It is the responsibility of the product user to determine the suitability of this product for a specific application. All trademarks property of their respective owners. © Thomson Industries, Inc. 2014

 **THOMSON**[®]
Linear Motion. Optimized.™